



HARLEQUIN
www.harlequinfloors.com

A guide to

DANCE FLOORS AND STUDIO EQUIPMENT



THE WORLD DANCES ON HARLEQUIN FLOORS®

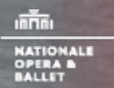

Harlequin is the world leader in advanced technology flooring for dance and the performing arts. Established in the UK over 40 years ago, Harlequin remains the industry choice for the world's most prestigious dance and performing arts companies, theatres, venues and schools.

Harlequin's experience and reputation are founded on the manufacture and supply of a range of high quality portable and permanent sprung and vinyl floors, ballet barres and mirrors for dance studios and performance spaces. Preferred by dancers and performers at the world's leading venues, from the Royal Opera House, the Bolshoi Theatre, Paris Opera Ballet to the Royal New Zealand Ballet. Harlequin is the global leader in its field with offices in Europe, the Americas and Asia Pacific.



SUSTAINABILITY

Harlequin is committed to sustainable development and our corporate responsibility in this area forms a fundamental part of our business strategy. We believe that sustainability is a team effort across the entire company, driven and supported by our board of Directors.

We continually monitor the environmental impact of our manufacturing processes and operations and ensure that every department works together to plan, measure and improve our social and environmental performance.

This plan is continually being reviewed to meet our ongoing commitment to improve our overall sustainability and to reduce carbon emissions, helping us to reach Net Zero emissions.

Harlequin Wood Flooring

- All timber used by Harlequin is responsibly sourced from sustainable well managed forests that are either FSC or PEFC certified.
- Harlequin has demonstrated their commitment to sustainability by gaining FSC 'Chain of Custody' Certification.
- Harlequin is the only performance floor manufacturer to use sustainable bio-based lignin glue in their birch plywood products, giving significant reduction in carbon footprint and VOC emissions.
- All Harlequin wood flooring is 100% recyclable and can be converted into sustainable biomass to generate energy.
- Our Harlequin Activity floor has exceptionally high thermal and sound insulation properties helping to reduce noise transmission and energy use.
- All Harlequin timber waste and installation offcuts are sent for recycling for conversion into sustainable biomass to generate energy.



Harlequin Vinyl Flooring

- Harlequin is committed to reuse and recycle all Harlequin products wherever possible.
- Harlequin runs a proactive 'Take Back' scheme under which post installation and post use products are recycled into second life products. All Harlequin vinyl flooring is 100% recyclable. Any Harlequin vinyl floor can be returned to our UK warehouse (or collected for a fee) for recycling. T&C's apply.
- Since Harlequin Floors introduced their 'committed to recycling' scheme, diverting material away from landfill, the programme has saved 282 tonnes of CO² emissions.
- All Harlequin vinyl flooring contains between 23%-30% post manufacture recycled content.
- Harlequin vinyl floors are extremely durable and are designed to be reused many times. Some prestigious dance companies have been using their Harlequin Cascade floors for over 20 years. Our Harlequin Hi-Shine the choice of touring bands who use it night after night on the road. Our Harlequin Fiesta is designed to be used without glue, making reuse and recycling much easier. And our Harlequin Reversible floor is 'two floors in one', if one side becomes worn it can be easily turned over to use the other side so doubling the life of the floor.
- Harlequin's own range of specialist cleaning products help to protect our vinyl floors so extending the life cycle of our products.
- Unlike other manufactures, we offer our vinyl floors in a wide range of roll length enabling our customers to by the amount of flooring that they actually need, so reducing waste.
- All Harlequin vinyl flooring products have been tested for VOCs, achieving Intertek's Clean Air Gold Certification for emissions and complying with both BREEAM (Building Research Establishment Environmental Assessment Method) and LEED (Leadership in Energy & Environmental Design) requirements for good indoor air quality.
- Harlequin uses only solvent free adhesives and print inks.
- Harlequin vinyl flooring is manufactured from 56% renewable ingredients.
- All raw materials used in the manufacture of Harlequin vinyl flooring are REACH (Registration, Evaluation, Authorisation and Restriction of Chemicals) compliant and do not contain any SVHC (Substances of Very High Concern) in concentrations greater than 0.1% (w/w).
- All Harlequin vinyl flooring products contain no CMR (Carcinogenic, Mutagenic, Reprotoxic) Category 1 or 2 substances.
- All Harlequin vinyl flooring products are free from formaldehyde and are classified as conforming to Class E1.
- Harlequin conforms to the recommendations of Vinyl Plus, the European PVC industry's commitment to sustainable development.

BREEAM®

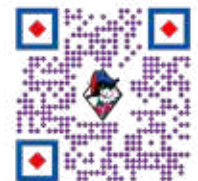

WHO WE WORK WITH

Harlequin is the industry expert with over 45 years' experience building and refurbishing theatre stages and dance studios. The world's most prestigious dance companies, venues, universities, and schools trust and recognise the advantages that good quality products and service synonymous with the Harlequin brand can provide.

Harlequin manufactures, supplies and installs quality performance floors and stages in venues ranging from international opera houses and theatres, dance companies and performing art schools to high-end events, TV & film production, cruise ships and leisure venues.



English National Ballet



Princess Grace Academy



Birmingham Hippodrome



Kingston University



We work with architects and contractors, stage and theatre engineers, event producers and end clients. From a 4000 square metre arena in China to a private studio conversion, all enquiries are handled on a one-to-one basis by our expert technical team.

Harlequin has an extensive range of sprung and vinyl floors, mirrors, ballet barres and dance studio equipment and can provide everything that a good performance space requires.

Phoenix House School



Haraka Center for Movement of Arts



Eventim Apollo



Playground London



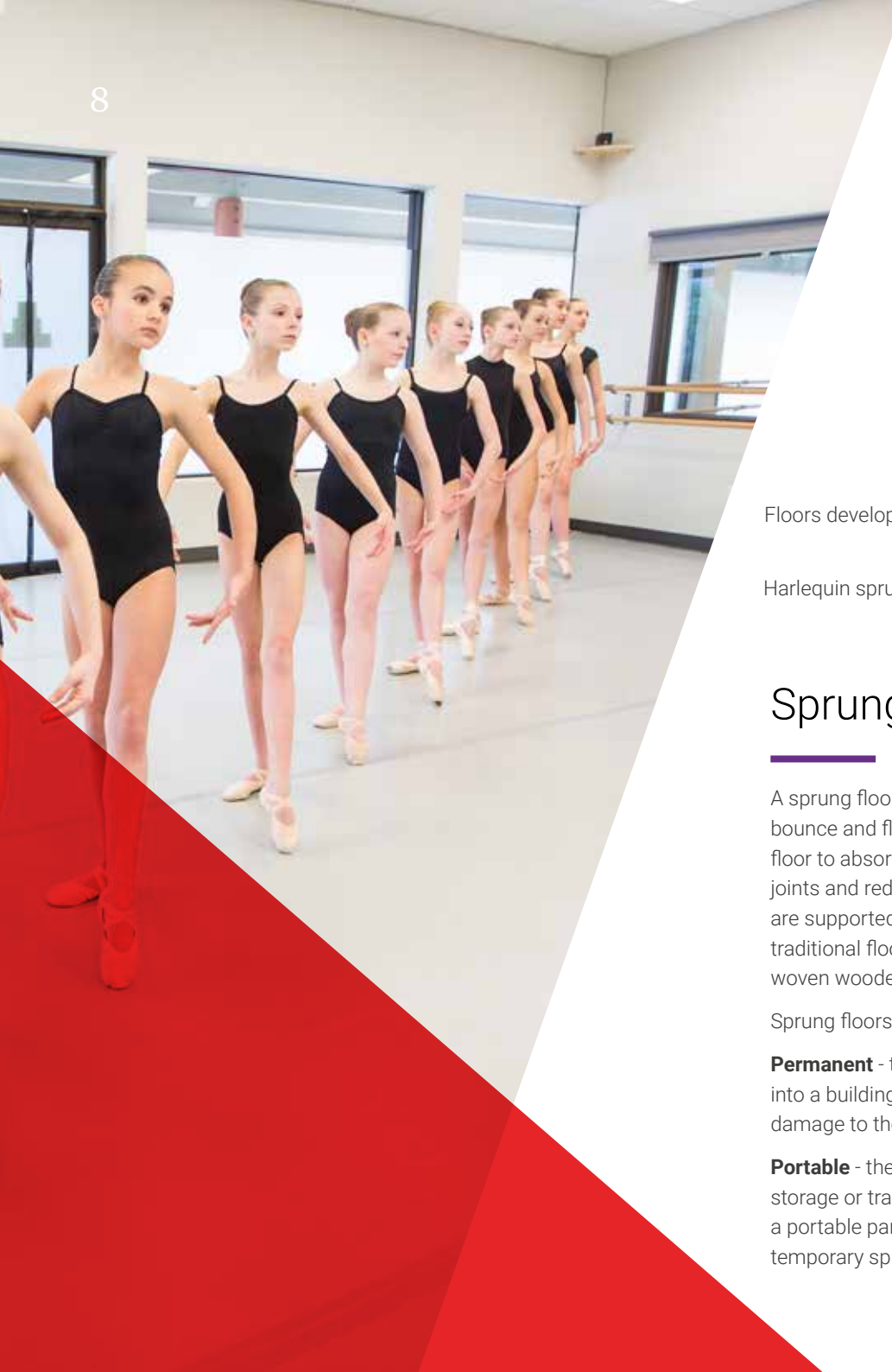

CONSIDERATIONS WHEN CHOOSING A DANCE FLOOR

Floors developed for commercial or sports applications do not offer the benefits that dancers appreciate when they talk about the 'feel' of the floor. Only floors developed for dance do that.

Harlequin sprung floors offer assurance of better protection from injuries for dancers with reduced risk of injury through impact, slipping or falling and a professional dance floor enhances the confidence of performers.

Sprung floors

A sprung floor is a floor that provides some degree of bounce and flexes under impact. Performers need a floor to absorb the shock of repeated impact to their joints and reduce injury from falls. Modern sprung floors are supported by foam backing or rubber pads while traditional floors provide their spring through bending woven wooden battens.

Sprung floors can be permanent or portable.

Permanent - the sprung floor is permanently installed into a building and cannot be removed without risking damage to the floor.

Portable - the sprung floor can be easily removed for storage or transportation. Harlequin have developed a portable panel system suitable for touring or as a temporary sprung floor.

Vinyl performance surface

For optimum safety it is recommended to install a Harlequin vinyl floor as a dance surface on a Harlequin sprung floor, offering added assurance for better protection from injuries. Vinyl floors can be permanent, semi-permanent or portable.

Permanent - the vinyl floor is stuck down with adhesive with the seams sealed by hot or cold welding and cannot be removed without risking damage to the floor.

Semi-permanent - the vinyl floor is loose-laid using double-sided tape and then welded at the seams. The seams can later be cut and the vinyl floor taken up.

Portable - the vinyl floor is loose-laid with the joins either covered with tape or temporarily secured to the sub-floor with double-sided tape.

Wood performance surface

A wood performance surface is often specified for ballroom dance, multipurpose use or to match existing decor. Harlequin offer a range of solid hardwood and engineered wood top surfaces. Please contact us for details.

Size of dance space

There are varied space requirements for differing dance genres.

School-aged children require 3m² per participant; senior schools/further education and adults require 5m² per participant.

Headroom is also a consideration with a ceiling height of 3.5m being optimum.

Portable or permanent dance floors

In a multi-purpose venue where the space is not dedicated solely to dance and for touring purposes where floors are transported to and used in other venues, a roll-out, loose-lay floor is a practical solution.

A portable floor is also suitable for spaces where permanent installation is prohibited. Portable vinyl floors are supplied in rolls for storage and transportation.

Portable sprung floors are supplied as panels that can be linked together. Harlequin vinyl floor is then rolled out onto them and taped in place.

Area and point-elastic

An area-elastic floor flexes over a wider area to avoid the 'trampoline effect', whereas a point-elastic floor has deflection or 'give' only at the point of contact.

A cushioned vinyl performance surface is point elastic. Area elasticity is provided only by a sprung floor.



HARLEQUIN'S RANGE OF SPRUNG FLOORS

Sprung floors are most commonly used in permanent installations, although Harlequin has developed a portable panel system that is also suitable for touring companies as a temporary sprung floor solution.

The Harlequin range of sprung floors have been developed for use in combination with a vinyl or wood performance surface.

Harlequin WoodSpring sprung floor with vinyl performance surface

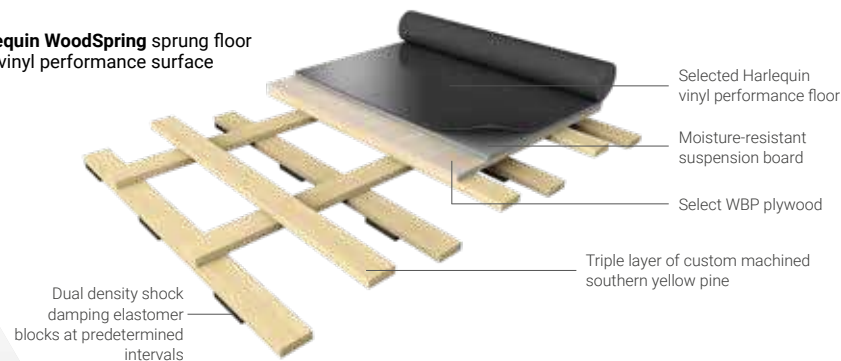

Harlequin WoodSpring sprung floor with solid hardwood or engineered board surface

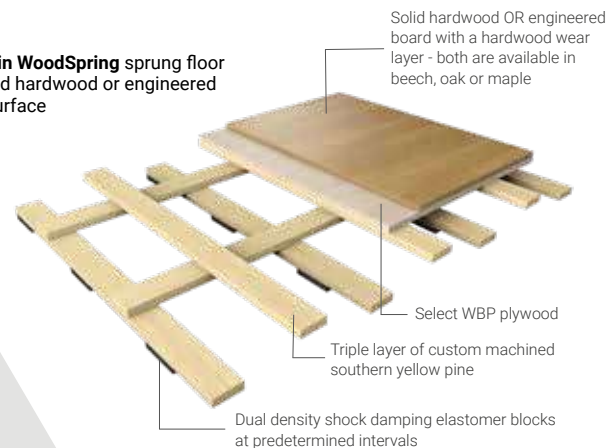

Harlequin WoodSpring
Scottish Ballet

Harlequin WoodSpring™

- Permanently installed sprung floor
- Modern update of the traditional basket weave construction
- 'Industry standard' choice for permanent installation by Harlequin Contracts Division
- Minimum floor thickness:
 - 82mm before inclusion of chosen wood finish (96mm with 14mm engineered wood)
 - 91mm before inclusion of chosen vinyl finish (93mm with 2mm vinyl)
- Guaranteed for 10 years (T&Cs apply)

Harlequin WoodSpring comprises a layer of select WBP (weather and boil proof) plywood, a triple-layer of custom machined southern yellow pine laid at right angles, with shock absorption and energy return enhanced by dual density elastomer blocks attached at pre-determined intervals to the underside.

Surface options include:

- A Harlequin vinyl performance floor
- Bespoke solid hardwood
- Engineered wood with a hardwood wear layer in beech, oak or maple

If a Harlequin vinyl performance floor is chosen, a moisture resistant suspension board will be included underneath, along with a colour matched composite edging profile which will be installed around the finished edges. If solid hardwood or engineered board is chosen, the skirting/scotia will be optional.

Harlequin Activity™

- Permanently installed sprung floor
- Harlequin 'triple sandwich' proprietary construction method
- A fully-floating system without fixings to the sub-floor
- Can be laid on any smooth and flat surface without prior preparation
- 'Industry standard' choice for permanent installation by Harlequin Contracts Division

Harlequin Activity sprung floor with vinyl performance surface.

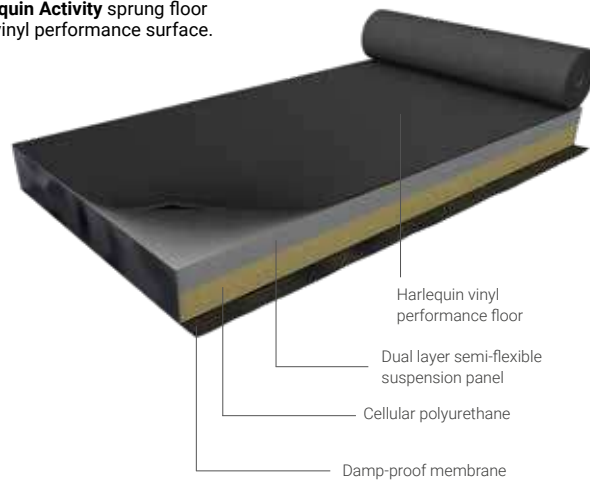

If a Harlequin vinyl performance floor is chosen, a colour matched composite edging profile can be installed around the finished edges. If solid hardwood or engineered board is chosen, the skirting will be optional.

Harlequin Activity provides shock-dampening to avoid a 'trampoline' effect plus area elasticity to offer identical characteristics across the whole floor. It is an 'industry standard' choice with many hundreds of installations worldwide, effectively reducing injuries to both teachers and performers.

A performance top surface will also be required.

Surface options include:

- A Harlequin vinyl performance floor
- Bespoke solid hardwood
- Engineered wood with a hardwood wear layer in beech, oak or maple
- Minimum floor thickness: 46mm before inclusion of chosen vinyl finish, 38mm before inclusion of chosen wood finish
- Guaranteed for 10 years (T&Cs apply)

Harlequin Activity sprung floor with solid hardwood or engineered board surface.



Harlequin Liberty™

- Permanent, semi-permanent and portable
- Modular sprung floor panel system
- Panels are laid in a brickwork fashion onto the sub-floor so that cross-joins do not coincide
- Panels join together by a rounded tongue and groove secured in place using Harlequin's proprietary 'one turn of the key' latch and lock mechanism
- Minimum floor thickness 37mm (before inclusion of chosen finish)
- Panel size 2m x 1m and 1m x 1m
- Guaranteed for 10 years (T&Cs apply)

Harlequin Liberty panels are fully supported by dual density shock dampening elastomer pads spaced at regular intervals, giving uniform and consistent shock dampening and providing the same "feel" and energy return to one or several dancers on the same panel, and with no hard spots at the joints.

It is finished by choosing an appropriate Harlequin vinyl performance floor with accompanying ramps and edge trims where required. Installation can be carried out either by the customer or by Harlequin's technical installation team.

Harlequin Liberty sprung floor panels and the accompanying portable Harlequin vinyl performance floor can also be stored in carts, providing an easy and safe way for stage crew to move them on tour or around a venue.



Harlequin latch and lock system

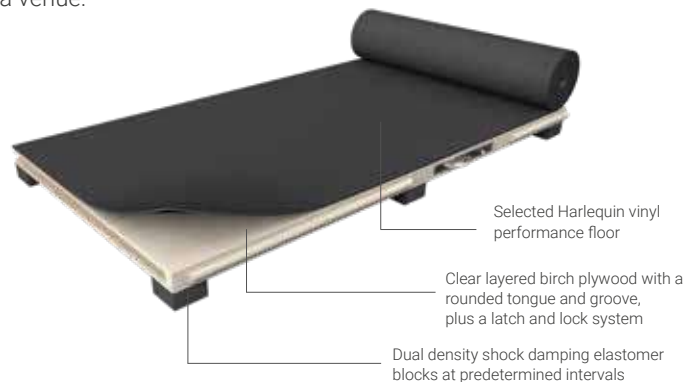

Harlequin Liberty HD™

Harlequin Liberty HD is a further development of our renowned Liberty panel system, designed with enhanced durability in mind for more challenging environments. Installed permanently or as a portable floor, panels are laid in a brickwork fashion onto the sub-floor so that cross joins do not coincide. The panels join together by a rounded tongue and groove and are secured using our 'one turn of the key' latch and lock mechanism.

Harlequin Liberty HD panels are coated with a black polymer resin on both sides and have a textured, high grip pattern on the top surface, which is wear resistant, anti-slip and weatherproof.

Harlequin Liberty HD panels can be finished by choosing an appropriate Harlequin vinyl performance floor from our range. For permanent and semi-permanent use, installation can be carried out either by the customer themselves or by our highly-skilled technical team.

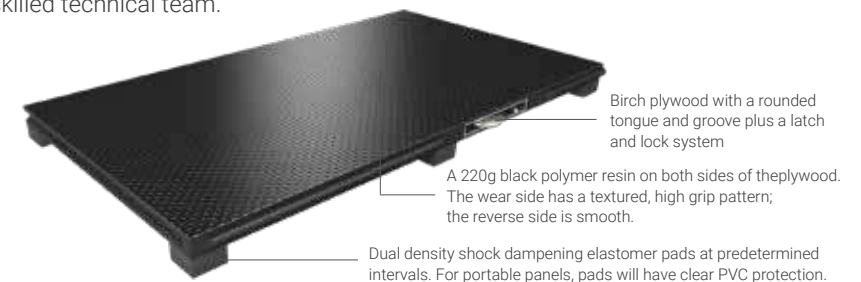

See Liberty Accessories on page 26

Harlequin Liberty Ballroom™

Harlequin Liberty Ballroom is a sprung floor panel system, designed for permanent or portable installation. Panels are laid in a brickwork fashion onto the sub-floor, so that cross joints do not coincide. The panels join together by a rounded tongue and groove, which is secured in place using our 'one turn of the key' latch and lock mechanism.

Harlequin Liberty Ballroom is suitable for permanent and semi-permanent use, installation can be carried out either by the customer themselves or by our highly skilled technical team. The surface has an elegant wood effect print and is protected by a hard wearing lacquer for longevity.

Harlequin Liberty Ballroom sprung floor panels can also be stored in carts, providing an easy and safe way for stage crew to move them on tour or around a venue.



Harlequin Liberty Switch™

Harlequin Liberty Switch is a professional multi-use floor system which transforms between a rigid theatrical floor and a sprung performance floor at the touch of a button.

It is designed for venues who regularly put on both dance and theatrical performances and so require both a sprung and a rigid floor in the same performance or rehearsal space.

Harlequin Liberty Switch enables a Harlequin Liberty sprung floor to be transformed to a rigid (unsprung) floor quickly and easily. This is achieved by using moving carriages which engage with stop blocks on the underside of the Liberty panels to create a rigid floor and disengage to create a sprung floor.

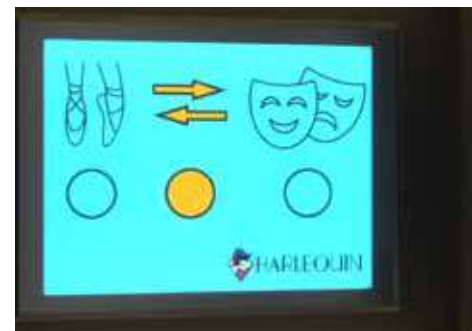

Harlequin Flexity™

Harlequin Flexity is a cost-effective, self-install sprung floor panel system, designed for permanent or semi-permanent installation. Panels are laid in a brickwork fashion onto the sub-floor, so that cross joints do not coincide. The panels join together by a special tongue and groove, which are glued together for permanent installation or fixed using woodscrews at predetermined points along the tongue and groove for a semi-permanent solution.

- Suitable for self-install for home dance studios
- Minimum floor thickness 37mm (before inclusion of chosen finish)
- Panel size 1.125m x 2.250m / Dance surface area 1.089m x 2.214m
- Guaranteed for 10 years (T&Cs apply)

Harlequin Flexity is finished by choosing an appropriate Harlequin vinyl or wood performance surface from our range.

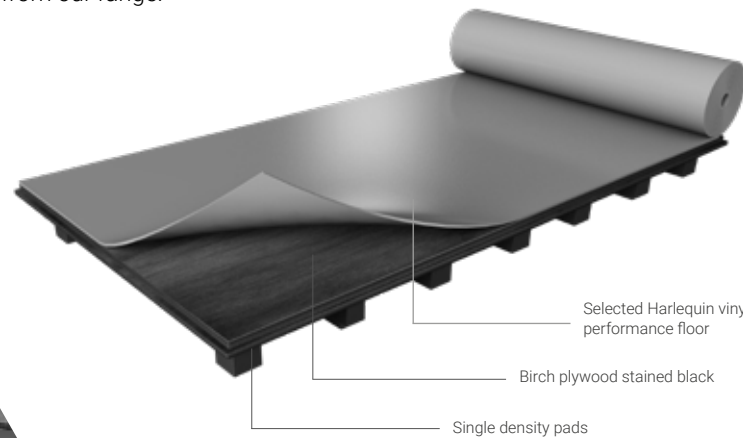

HARLEQUIN'S RANGE OF VINYL FLOORS

Harlequin's range of vinyl floors can be laid on any hard, smooth sub-floor, used alone or as a dance surface on a sprung floor. They offer added assurance for better protection from injuries for dancers, providing them with a feeling of optimum safety.



Which floor is right for you?

Harlequin's range of surfaces have been developed to meet the needs of the dance community. The range includes vinyls with varying degrees of cushioning, durability and grip or 'traction'.

- Classical ballet requires a soft surface with some degree of traction
- Street and hip-hop dancers usually wear trainers so require less traction. Too much can block movement and cause injury
- Contemporary dance includes a lot of barefoot work and other parts of the body are in contact with the floor, so a slightly cushioned surface may be preferable

We also offer other specialist products:

- Harlequin Hi-Shine, a high gloss reflective performance vinyl for production, events and display.
- Harlequin Marine, a vinyl performance surface for cruise ships and other leisure applications.
- Bespoke printed vinyl flooring

Visit our website or call our customer services team for more information.

Application Guide

Specification Guide

	Aerobics/Zumba	Ballet	Ballroom/Salsa	Contemporary	Hip-Hop/Jazz/Street	Modern	Percussive* (Flamenco, Irish, Tap)	Theatre/Opera	Permanent or Portable	Roll width (m)	Roll length (m)	Thickness (mm)	Weight (kg/m ²)	Standard colours	Fire rating
Allegro	✓			✓	✓	✓			Permanent	1.5	10, 15, 18, 20	8.5	6	Black (180), Grey (880)	Cfl-s1 (EN 13501-1)
Cascade	✓	✓		✓	✓	✓	✓	✓	Both	2	10, 15, 18, 20, 25	2	2.6	Black (501), Light grey (582), Dark grey (406), Hazelnut (470), White (100)	Bfl-s1 (EN 13501-1)
Clarity	✓	✓	✓	✓	✓	✓	✓	✓	Both	1.52	15	1.9	2.47	Clear	Cfl-s1 (EN 13501-1)
Fiesta	✓		✓		✓	✓	✓	✓	Both	2	15, 20, 25	2.45	3.4	Oak strip effect (261)	Bfl-s1 (EN 13501-1)
FreeStyle	✓			✓	✓				Both	1.5	15, 20, 25, 30	4.5	2.67	Black (180), Grey (880)	Cfl-s1 (EN 13501-1)
Reversible	✓	✓		✓	✓	✓	✓	✓	Portable	2	10, 15, 18, 20, 25, 30	1.3	1.6	Dark grey/Light grey (003), Black/White (001), Black/Grey (004), Chroma key blue/Green (119), Fog/Tan (890), Hazelnut/Beige (310), Projection Grey/Black (005), Red/Black (302)	Bfl-s1 (EN 13501-1)
Reversible Pro	✓	✓		✓	✓	✓	✓	✓	Portable	2	10, 15, 18, 20, 25, 30	1.5	2.25	Black/Grey (004), Black/White (001)	Bfl-s1 (EN 13501-1)
Standfast	✓	✓		✓	✓	✓	✓	✓	Permanent	1.5	10, 15, 20	2.6	3.4	Black (501), Grey (004), Dark grey (406)	Cfl-s1 (EN 13501-1)
Studio	✓	✓		✓	✓	✓			Both	1.5	10, 15, 18, 20, 25, 30	3	2.3	Black (180), Grey (880), Dark grey (890), White (100), Light grey (156)	Bfl-s1 (EN 13501-1)
Marine							✓	✓	Permanent	2	20	2	3.35	Black (501)	IMO FTP Code part 2 & 5

Harlequin Cascade™

Harlequin Cascade has delighted generations of professional dancers, artistic directors, technical directors and stage managers. The silky-smooth embossed surface provides excellent grip and is often described as giving 'warmth' to a dance performance.

Harlequin Cascade is the ultimate heavy-duty vinyl dance floor, with mineral fibre reinforcement for stability and durability. It is widely used as a ballet floor but is also a popular choice for many other dance styles.

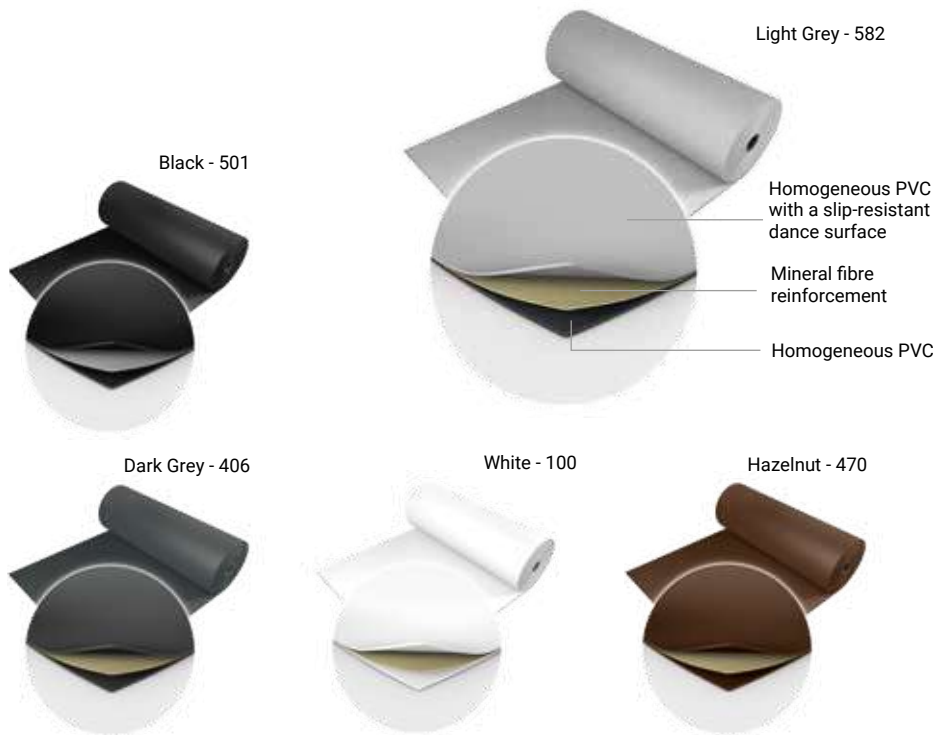

Harlequin Studio™

Harlequin Studio is a hard-wearing vinyl designed to meet the needs of dancers. The result is a slip-resistant floor that offers dancers added confidence for demanding choreography and movement.

- Suitable for ballet, contemporary and modern dance, aerobics, zumba, hip-hop, jazz, street
- Firm lightweight foam backing provides protection and is a great choice when touring
- For loose-lay or permanent installation
- Can be laid on any hard, smooth sub-floor and is an excellent choice as the vinyl performance surface in conjunction with a Harlequin sprung floor

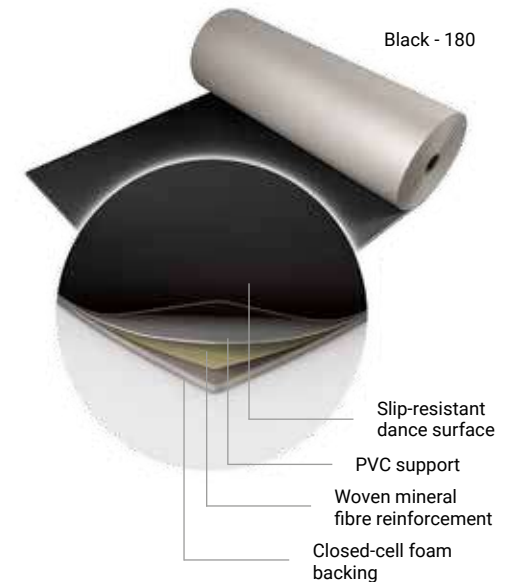

Harlequin Standfast™

Harlequin Standfast is a hard-wearing, durable performance floor that is intended for permanent installation using adhesive. The joints are heat welded to form a continuous performance surface.

- Suitable for ballet, contemporary, modern, percussive dance including flamenco, Irish and tap, multi-purpose use, hip-hop, jazz, street, aerobics, zumba, television, theatre and for operatic performances
- Permanent multi-purpose dance floor
- Can be laid on any hard, smooth sub-floor and is an ideal heavy duty stage surface

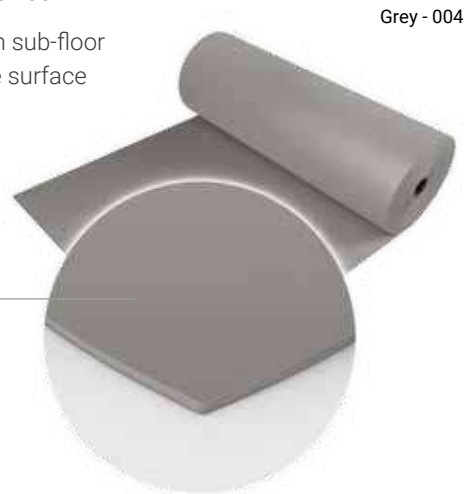

Homogeneous PVC with a slip-resistant performance surface



Harlequin Fiesta™

Harlequin Fiesta was developed because of the need for a floor which looked exactly like wood, but without all the associated problems of cleaning and maintenance. The floor's oak-strip performance surface provides the ideal solution.

- Suitable for ballroom, salsa, percussive including flamenco, Irish and tap, multi-purpose use, hip-hop, jazz, street, aerobics, zumba and for use in theatres and for operatic performances
- For permanent installation (joints are welded to provide a continuous surface)

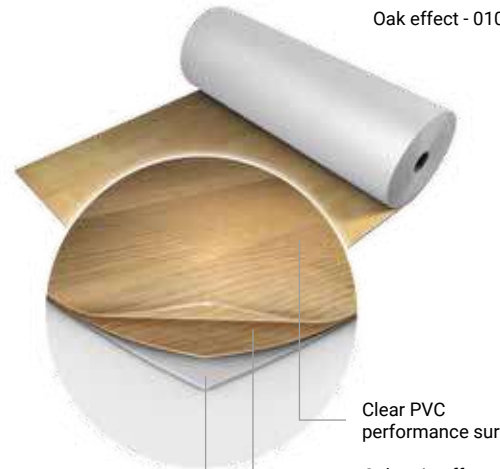
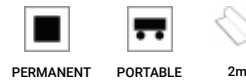

Clear PVC performance surface

Oak strip effect printed film

Stable impregnated polyester backing

Harlequin Fiesta
Base Studios London



Harlequin Reversible™

Harlequin Reversible is the original double-sided dance and stage floor. It is a lightweight calendered vinyl that rolls out quickly, lays flat and stays flat. It is hard-wearing and slip-resistant on both sides.

- Suitable for ballet, contemporary, modern, percussive dance including flamenco, Irish and tap, multi-purpose use, hip-hop, jazz, street, aerobics, zumba, concerts, display, exhibitions, television, theatres and operatic performances
- Versatile loose-lay floor in a wide range of colour options, it is ideally laid on any hard, smooth surface and is suited to touring due to ease of handling and portability



PORTABLE 2m

Dark grey/Light Grey - 003



Black/White - 001



Chroma Key Green/
Chroma Key Blue - 119



Red/Black - 302



Fog/Tan - 890



Hazelnut/Beige - 310



Black/Projection Grey - 005



Black/Grey - 004



Calendered vinyl with a slip-resistant performance surface

Harlequin Reversible Pro™

Harlequin Reversible Pro has the same features as Harlequin Reversible but with the addition of a new mineral fibre interply layer, it offers even more dimensional stability, making it an ideal surface for printing.

- Suitable for a wide variety of uses including ballet, contemporary, percussive dance including flamenco, Irish and tap, multi-purpose use, hip-hop, jazz, street, aerobics, zumba, concerts, display, exhibitions, television, theatres and for operatic performances
- Heavy duty
- Highly portable and easy to handle
- Quick to roll out and lays flat
- Ideal for touring



PORTABLE 2m

Black/Grey - 004



Black/White - 001



Slip resistant wear coat

Woven mineral fibre reinforcement

Slip resistant wear coat

Harlequin FreeStyle™

Harlequin FreeStyle was specifically developed to meet the needs of hip-hop and street dancers who required a floor that provided less slip-resistance, enabling them to move freely yet safely.

- Suitable for hip-hop, jazz, street dance, contemporary and modern dance, aerobics and zumba
- For loose-lay or permanent installation



Harlequin Allegro™

Harlequin Allegro is the thickest roll-out dance flooring available worldwide and provides protection for dancers due to its cushioning, point-elasticity and slip-resistant dance surface.

- Suitable for contemporary, modern, hip hop, jazz, street dance, aerobics and zumba
- Minimises impact injuries and performer fatigue
- Heavy duty floor
- For loose-lay or permanent installation

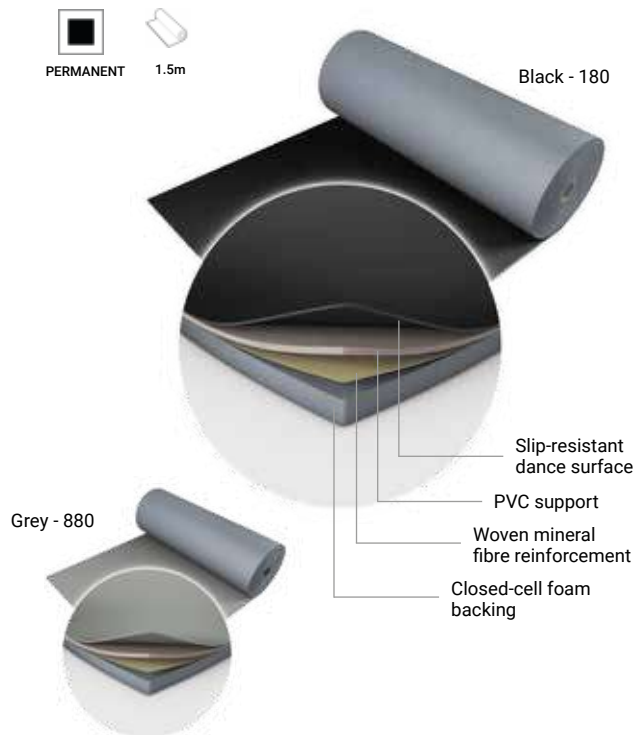

Harlequin Marine™

Harlequin Marine conforms to International Marine Organization (IMO) standards and fire ratings and is extensively installed on cruise liners. It is a hard-wearing, homogeneous PVC dance floor with a slightly marbled surface to resist scuffing.

- Specified for permanent installation
- Suitable for fitting within confined spaces on marine vessels
- Can be laid on any hard, smooth sub-floor



Harlequin also provide specialised dance floor installation and stage building services for cruise ships, to ensure that the flooring is installed appropriately. Please visit our Specifying Floors for Architects page if you are an architect looking to install Harlequin marine vinyl performance flooring.

Harlequin Clarity™

Harlequin Clarity is a durable clear vinyl flooring with an embossed texture suitable as a dance surface and for high traffic commercial use. It is specially formulated for bespoke reverse digital printing. The printed design is on the underside of the floor and so protected from wear and damage. Harlequin Clarity can also be used as a clear protective wear layer which allows the floor underneath to show through. Harlequin Clarity has the highest abrasion classification available. It is ideal for ballet, contemporary and modern dance theatrical use, aerobics, zumba, hip-hop, jazz, street, salsa, percussive including flamenco, Irish and tap, multi-purpose use, concerts, operatic performances and high traffic commercial purposes.



PERMANENT



PORTABLE



1.52m, 2.13m

Homogeneous PVC
with a slip-resistant
dance surface



Harlequin Printed Vinyl

Harlequin's printing service allows you to choose your own design adding an exclusive, new dimension to your Harlequin floor. A printed finish is available with Harlequin Clarity, Harlequin Cascade or Harlequin Reversible Pro vinyl floors. Your printed floor can be either large or small scale, depending on your needs.

Printed vinyl flooring is perfect for theatre productions, touring performances and product launches as well as events and display, sets, exhibitions and museums.

Colour matching available:

- Eco-friendly, solvent-free UV cured inks mean very rapid drying times
- Excellent ink adhesion to the substrate gives a durable, abrasion resistant surface
- The fire rating of the Harlequin floor is unaffected

Artwork requirement for digital printing:

- Print ready PDF and CMYK colours
- Large sizes can be supplied scaled down but must be in correct proportion to the final output
- Pantone colours will be printed as CMYK
- Minimum area for print 25m²
- Trimming is available depending on graphic layout



Bolshoi Theatre Moscow



Romeo and Juliet, Beyond Words



BALLET BARRES

Whether you choose portable freestanding or permanent wall-mounted ballet barres, you will realise they are almost a prerequisite for the dancer. Barre exercises focus on flexibility, strength, balance and precision. They also add a finishing touch to a dance studio or rehearsal space.

Choose from single, double, square or oval, with custom bracket designs available to order.



All available in colours black, grey, white, metallic and chrome plated

Single and double wall-mounted brackets & barres

Harlequin's wall-mounted ballet barres feature various shaped mounting plates to suit the design of your studio.

- Brackets are supplied complete with screws and plugs and can be mounted at any height: four fixings for the single bracket and six fixings for the double bracket
- Recommended height from the floor to the centre of the top of the barre 1052mm (ISTD / RAD recommend between 1020 - 1150 mm)
- Barres are set at 21cm from the wall to the centre of the barre. On the double bracket the two wooden barres are spaced 20cm apart
- Lengths of barre can be joined inside the bracket heads to hide the joins and give the impression of a continuous length of barre. For example, along the entire length of a studio wall
- Choice of bracket colour: black, grey and white available as standard. Additional colours include metallic and chrome plated
- Wooden barre is 5cm (1.9") in diameter and 150cm (59") long. 2.3m length available in beech
- Wooden barres come in an uncoated, natural sanded finish

Single brackets

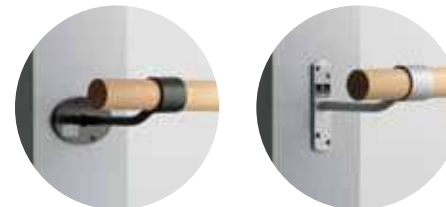

Pillar brackets



Double brackets

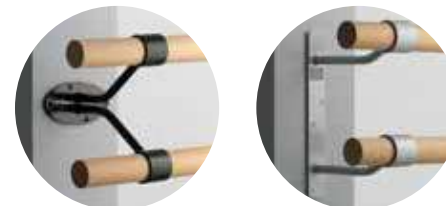

Under window wall-mounted brackets



Floor-mounted brackets

There are many occasions when it is not possible to fix ballet barre brackets onto a wall - perhaps in front of mirrors or where a wall is not suitable to accept fixings.

Harlequin offers two types of floor-mounted ballet barres. The standard floor-mounted bracket is designed to be fitted at the same time as the installation of a Harlequin sprung floor, the vertical leg of the barre support is mounted onto the substrate and the sprung floor built around it.

The retro-fit floor-mounted bracket can be mounted onto an existing floor, providing it is not sprung.

Under window wall-mounted brackets and pillar brackets

Custom designed brackets to allow wall barres to be fitted across most windows or obstructions. Available to order.

Ballet barre corner angle sleeves

Harlequin's ballet barre corner angle sleeve is specifically used to join the ends of two Harlequin pine or beech barres within a corner.

Ballet barre corner angle sleeve



Retro-fitted floor mounted brackets

Harlequin retro-fitted floor-mounted brackets are constructed from high grade steel with a powder coated finish. The base is fitted with a cover plate to hide the floor fittings and provide a streamlined look to your studio.

Harlequin retro-fitted floor-mounted brackets can be fitted professionally or purchased for self-install. The brackets are available black from stock and a range of colours to order.

Base plate cover lifted



Base plate cover flat



End brackets

A bracket specifically for fixing the end of a Harlequin wooden ballet barre to an adjacent wall.

End brackets



Floor-mounted brackets and barres

Single bracket

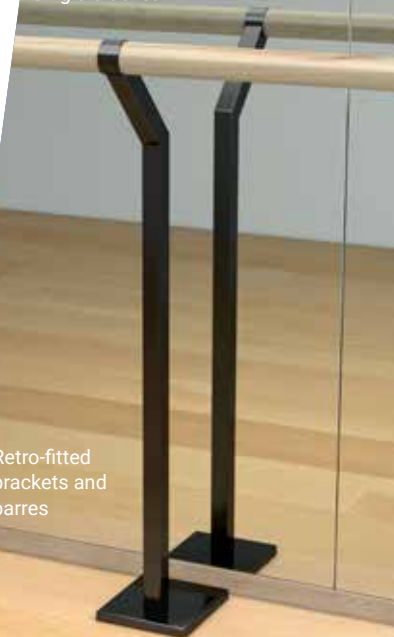

Double bracket



Retro-fitted brackets and barres

PLEASE NOTE: the wooden barres shown in the pictures are sold separately.
Available on web shop www.harlequinfloors.com/en/shop

Freestanding ballet barres

Our professional studio quality barres are lightweight yet very stable. Constructed from anodised aluminium with a smooth silver finish and a beech barre.

- Height from floor to top of lower barre - 82cm
- Height from floor to upper barre - 105cm
- Barre diameter - 4cm
- Total foot depth - 73cm
- Adjustable feet for stability on an uneven floor
- Wooden freestanding ballet barres come in an uncoated, natural sanded finish
- Large freestanding ballet barres are also available with your choice of aluminium or beech barre



Large freestanding ballet barre extension kit

Harlequin's freestanding portable ballet barre extension kit is constructed from anodised aluminium, with barres having a beech or smooth silver aluminium finish.

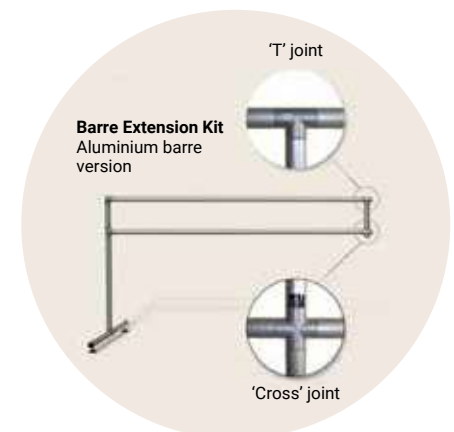

MIRRORS

Pilkington Optimirror™ OW Protect 6mm

Harlequin mirrors are an important fixture of any dance studio. For the dancer the mirror provides immediate visual feedback allowing them to evaluate the height and shape of their movement and line of their bodies. Enabling dancers to see themselves as the audience will see them is an important tool for technique training. Mirrors also benefit the dance teacher, offering greater visibility of their class and students from more angles. For smaller studios mirrors can create an impression of a larger and lighter area adding greater depth to the dance space.

Harlequin supplies and installs a bespoke range of the highest quality shatter-resistant mirrors and will ensure the mirrors are straight, level and true. The low iron Pilkington mirror provides a whiter, brighter appearance compared to a standard mirror. Harlequin mirrors conform to British & European safety standards - EN 12600 2(Class B)2.



HOME STUDIO RANGE

Home Studio Kits

Our Home Studio Kits are designed exclusively with a dancer's safety and comfort in mind.

All kits include Harlequin Liberty™ sprung floor panels, which effortlessly lock together and provide scientifically proven protection against injury.

Our kits also come with a Harlequin Cascade or Harlequin Reversible Pro vinyl to meet your specific dance needs. Available in three sizes: 2m x 1m, 2m x 2m and 3m x 2m, offering the ultimate platform on which to perfect your dance repertoire.





Harlequin Tap & Turn Board

Harlequin's Tap & Turn Board was designed specifically for percussive dancers. It provides exceptional sound, is solid underfoot and is the perfect size to practise those variations at home.

It is a 915mm x 800mm x 18mm exterior grade birch plywood board, topped on one side with Harlequin's slip-resistant Reversible dance vinyl. It has been used by performers from touring dance show 'Burn the Floor' for rehearsals. It can be used to protect existing flooring, or for practice in a carpeted bedroom. It also comes with a convenient handle to enable easy transportation.



Harlequin Practice Mat

Harlequin's Practice Mat has been designed to give dancers the chance to practise their dance moves on Harlequin Cascade, the floor of choice for: The Royal Ballet, New York City Ballet, The Bolshoi Ballet, English National Ballet, Riverdance, Sydney Dance Company, Royal Academy of Dance, Scottish Ballet, Glyndebourne Opera House, Sadler's Wells, Hong Kong Ballet, American Ballet Theatre, Trinity Laban Conservatoire and many more.

The Harlequin Practice Mat can be laid down to protect existing flooring and is the perfect size to practise those variations at home.

Available in sizes 1m x 1m and 2m x 1m.

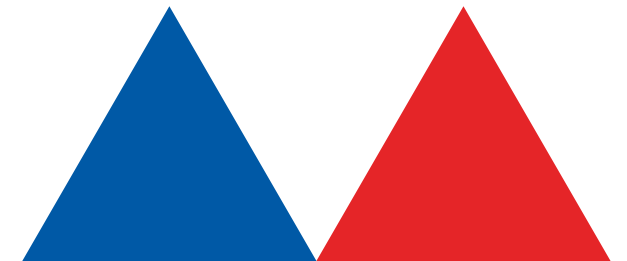

HARLEQUIN ACCESSORIES

Harlequin Liberty Sprung Floor Accessories

Corner pieces, edge trims and ramps

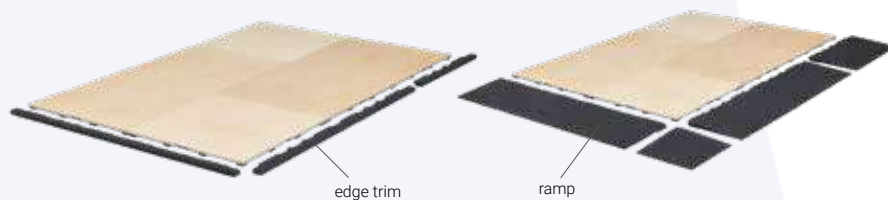

edge trim

ramp

Panel cart



Vinyl roll cart



Available on web shop www.harlequinfloors.com/en/shop

Vinyl floor tapes

Harlequin offer a comprehensive range of single and double sided gaffa and PVC tapes for use with Harlequin floors in all portable and semi-permanent situations.



Vinyl floor roll straps

Recommended to ensure Harlequin floors stay tightly wound on their cores when stacked away or in transit. They come in a range of sizes to suit our range of dance surfaces.



Vinyl roll storage bags

Recommended for protection of vinyl floors during transit and on tour. Made in durable polyester vinyl fabric with waterproof backing, they come complete with heavy-duty nylon webbing cradle straps for portability.



Cleaning and maintenance

Harlequin supply a range of products designed to prolong the life of your floor. For more information and advice, go to our website or contact our team.



Storage carts

Vinyl Roll Cart

Recommended to store or move larger rolls. Available in 1.5m and 2m versions for 4 or 6 rolls, black powder-coated steel.

Liberty Panel Cart

Recommended to store and move up to 20 Liberty panels black powder-coated steel

INSTALLATION

Harlequin sprung and vinyl floors can be fitted by Harlequin's specialist installation teams as part of our consultation and advice service to ensure your new floor is correctly installed and is fully compliant with current regulations and standards.

- Initial guidance in selecting the most appropriate floor for your requirements
- Site measurement service including floor levels survey, moisture content and 3D drawings
- Design of floors to suit existing spaces and conversions
- Design of floors for new builds and architect's plans
- Supply and installation of floors and accessories
- Harlequin on-site installation team to meet your building programme timescales
- Fully guaranteed (T&Cs apply)

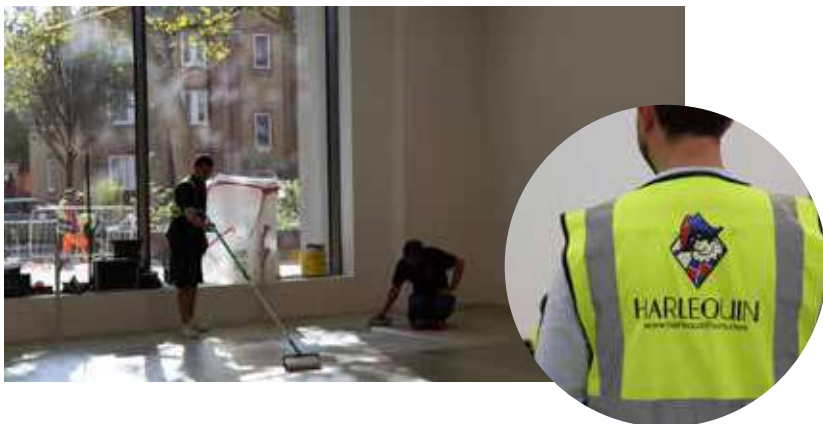

HIRING A HARLEQUIN LIBERTY SPRUNG FLOOR

Harlequin Liberty sprung floors are available for hire for all events, TV and film production and rehearsals.

Harlequin Liberty sprung floors are supplied with a selected Harlequin vinyl floor (to be purchased separately and not available to hire).

An out-of-hours installation service can be arranged to suit all set-up requirements.

Available for both short-term and long-term hire from a single day to several months.

SUSTAINABILITY

Harlequin is committed to sustainable development and our corporate responsibility in this area forms a fundamental part of our business strategy. We believe that sustainability is a team effort across the entire company, driven and supported by our board of Directors.

We continually monitor the environmental impact of our manufacturing processes and operations and ensure that every department works together to plan, measure and improve our social and environmental performance.

This plan is continually being reviewed to meet our ongoing commitment to improve our overall sustainability and to reduce carbon emissions, helping us to reach Net Zero emissions.

Harlequin Wood Flooring

- All timber used by Harlequin is responsibly sourced from sustainable well managed forests that are either FSC or PEFC certified.
- Harlequin has demonstrated their commitment to sustainability by gaining FSC 'Chain of Custody' Certification.
- Harlequin is the only performance floor manufacturer to use sustainable bio-based lignin glue in their birch plywood products, giving significant reduction in carbon footprint and VOC emissions.
- All Harlequin wood flooring is 100% recyclable and can be converted into sustainable biomass to generate energy.
- Our Harlequin Activity floor has exceptionally high thermal and sound insulation properties helping to reduce noise transmission and energy use.
- All Harlequin timber waste and installation offcuts are sent for recycling for conversion into sustainable biomass to generate energy.



Harlequin Vinyl Flooring

- Harlequin is committed to reuse and recycle all Harlequin products wherever possible.
- Harlequin runs a proactive 'Take Back' scheme under which post installation and post use products are recycled into second life products. All Harlequin vinyl flooring is 100% recyclable. Any Harlequin vinyl floor can be returned to our UK warehouse (or collected for a fee) for recycling. T&C's apply.
- Since Harlequin Floors introduced their 'committed to recycling' scheme, diverting material away from landfill, the programme has saved 282 tonnes of CO² emissions.
- All Harlequin vinyl flooring contains between 23%-30% post manufacture recycled content.
- Harlequin vinyl floors are extremely durable and are designed to be reused many times. Some prestigious dance companies have been using their Harlequin Cascade floors for over 20 years. Our Harlequin Hi-Shine the choice of touring bands who use it night after night on the road. Our Harlequin Fiesta is designed to be used without glue, making reuse and recycling much easier. And our Harlequin Reversible floor is 'two floors in one', if one side becomes worn it can be easily turned over to use the other side so doubling the life of the floor.
- Harlequin's own range of specialist cleaning products help to protect our vinyl floors so extending the life cycle of our products.
- Unlike other manufactures, we offer our vinyl floors in a wide range of roll length enabling our customers to by the amount of flooring that they actually need, so reducing waste.
- All Harlequin vinyl flooring products have been tested for VOCs, achieving Intertek's Clean Air Gold Certification for emissions and complying with both BREEAM (Building Research Establishment Environmental Assessment Method) and LEED (Leadership in Energy & Environmental Design) requirements for good indoor air quality.
- Harlequin uses only solvent free adhesives and print inks.
- Harlequin vinyl flooring is manufactured from 56% renewable ingredients.
- All raw materials used in the manufacture of Harlequin vinyl flooring are REACH (Registration, Evaluation, Authorisation and Restriction of Chemicals) compliant and do not contain any SVHC (Substances of Very High Concern) in concentrations greater than 0.1% (w/w).
- All Harlequin vinyl flooring products contain no CMR (Carcinogenic, Mutagenic, Reprotoxic) Category 1 or 2 substances.
- All Harlequin vinyl flooring products are free from formaldehyde and are classified as conforming to Class E1.
- Harlequin conforms to the recommendations of Vinyl Plus, the European PVC industry's commitment to sustainable development.

BREEAM®

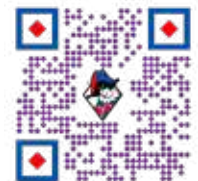

Australian Harlequin Pty Ltd

2/11 Penny Place Arndell Park Australia
Tel: +61 (2) 9620 7770
Email: auscontact@harlequinfloors.com

Harlequin Europe SA

29 rue Notre-Dame L-2240 Luxembourg

Harlequin Deutschland GmbH

Melanchthonstraße 16 D-10557 Berlin Germany

American Harlequin Corporation

1531 Glen Avenue Moorestown NJ 08057

British Harlequin plc

Festival House Chapman Way Tunbridge Wells Kent TN2 3EF

Australian Harlequin Pty Ltd
2/11 Penny Place Arndell Park Australia

Harlequin Asia Limited

2/F The Strand 49 Bonham Strand Sheung Wan Hong Kong



HARLEQUIN
www.harlequinfloors.com

